

With fuseholder 5x20 mm, with or without voltage selector (step switch)

Plug removal necessary for fuse replacement



Fuse drawer must be ordered separately (see accessories).

Fuse drawer must be ordered separately (see accessories).

Screw-on mounting from front side with voltage selector

C14



70° C



Description

- Panel Mount:
 - Screw-on version from front or rear side, snap-in version from front side
- 4 Functions:
 - Appliance inlet Protection class I, Fuseholder for fuse-links 5 x 20 mm 1- or 2-pole, with or without voltage selector (step switch), Line filter in standard and medical version
- Quick connect terminals or wires
- Alternative: version without line filter [KEA](#)

Approvals

- VDE License Number: 40004665 (FKE, FKF, FKV, FKW)
- UL License Number: E72928 (FKE, FKF, FKV, FKW)

Characteristics

- Rear side mounting for efficient cost-saving assembly
- Suitable for assembly in metal plated plastic housings
- All single elements are already wired
- Plug removal necessary for fuse-link replacement
 - The fuse drawer "Fingergrasp" can be removed by hand
 - For added safety "Extra-Safe" fuse drawers are available
 - Fuse drawer meets requirements of medical standard IEC/EN 60601-1
 - The fuseholder is accessible from the equipment front
- Qualified for use in equipment according IEC/EN 60950

Other versions on request

- Capacity CX 100 nF

References

[General Product Information](#)

Weblinks

[Approvals](#), [RoHS](#), [CHINA-RoHS](#), [e-Store](#), [SCHURTER-Stock-Check](#), [Distributor-Stock-Check](#)

Technical Data

Ratings IEC	1 - 10A @ Ta 40 °C / 250 VAC; 50 Hz	Appliance-Inlet/-Outlet	C14 acc. to IEC/EN 60320-1, UL 498, CSA C22.2 no. 42 (for cold conditions) pin-temperature 70 °C, 10A, Protection class I
Ratings UL/CSA	1 - 10A @ Ta 40 °C / 125 VAC; 60 Hz	Fuseholder	1 or 2 pole, Shocksafe category PC2 acc. to IEC 60127-6, for fuse-links 5 x 20 mm
Leakage Current	standard < 0.5 mA (250 V / 60 Hz) medical < 5 µA (250 V / 60 Hz)	Rated Power Acceptance @ Ta 23 °C	5 x 20: 2W (1 pole)/ 1.6W (2-pole) per pole
Dielectric Strength	> 1.7 kVDC between L-N > 2.7 kVDC between L/N-PE Test voltage (2 sec)	Power Acceptance @ Ta > 23 °C	Admissible power acceptance at higher ambient temperature see derating curves
Allowable Operation Temp.	-25 °C to 85 °C	Voltage selector	optional, step, 3 digits
Climatic Category	25/085/21 acc. to IEC 60068-1	Line Filter	Standard and Medical Version, IEC 60939, IEC 60601-1, UL 1283, UL 544, EN 133 200, CSA C22.2 no. 8 Technical details
Degree of Protection	from front side IP 40 acc. to IEC 60529	MTBF	> 1'700'000 h acc. to MIL-HB-217 F
Protection Class	Suitable for appliances with protection class I acc. to IEC 61140		
Terminal	Quick connect terminals or wires		
Panel Thickness s	Screw-on: max 8 mm Mounting screw torque max 0.5 Nm Snap-in: 0.8 mm to 3 mm		
Material: Housing	Thermoplastic, black, UL 94V-0		

Dimensions

Screw-on mounting from front side

Length |-----| 69 mm

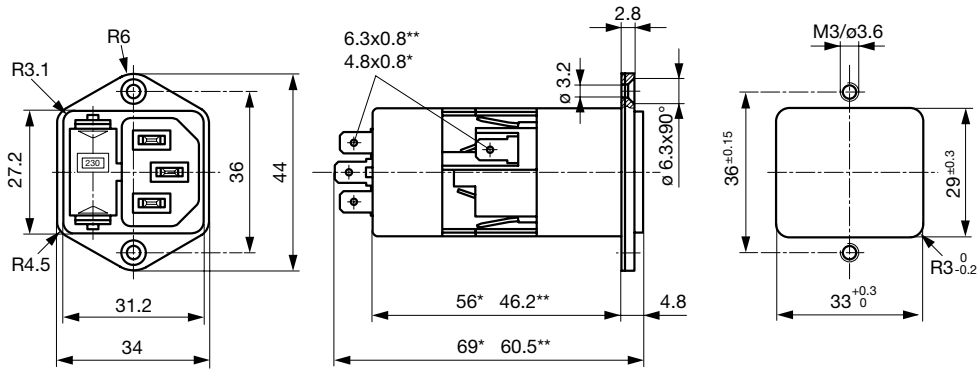

* with voltage selector

** without voltage selector

Screw-on mounting from rear side

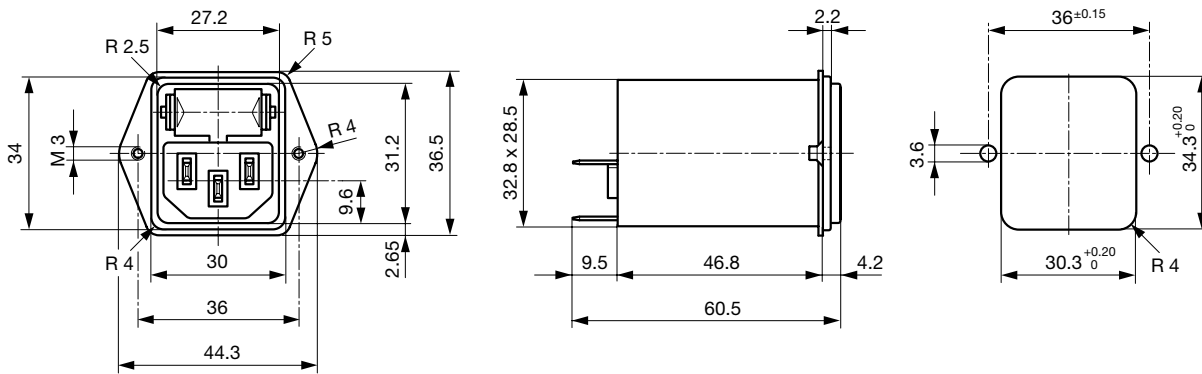

Snap-in mounting

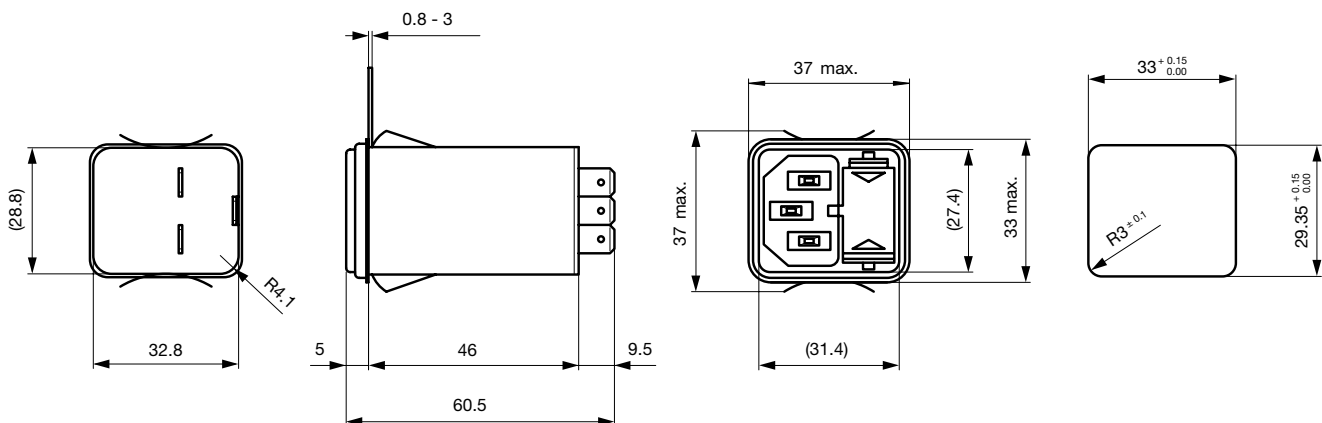

Technical Data of Filter-Components

Rated Current [A]	Filter-Type	Inductances L [mH]	Capacitance CX [nF]	Capacitance CY [nF]	R [MΩ]
1	Standard Version	2 x 10	68	2.2	-
2	Standard Version	2 x 4	68	2.2	-
4	Standard Version	2 x 1.5	68	2.2	-
6	Standard Version	2 x 0.8	68	2.2	-
10	Standard Version	2 x 0.3	68	2.2	-
1	Medical Version (M5)	2 x 10	68	-	1
2	Medical Version (M5)	2 x 4	68	-	1
4	Medical Version (M5)	2 x 1.5	68	-	1
6	Medical Version (M5)	2 x 0.8	68	-	1
10	Medical Version (M5)	2 x 0.3	68	-	1
1	Medical Version (M80)	2 x 10	68	0.47	1
2	Medical Version (M80)	2 x 4	68	0.47	1
4	Medical Version (M80)	2 x 1.5	68	0.47	1
6	Medical Version (M80)	2 x 0.8	68	0.47	1
10	Medical Version (M80)	2 x 0.3	68	0.47	1

Diagrams

Standard version with fuseholder 1- or 2-pole

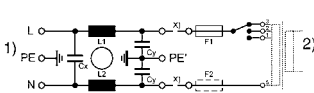

1) Line; 2) Load; x) external connection to be made by the customer

Medical version (M5) with fuseholder 2-pole

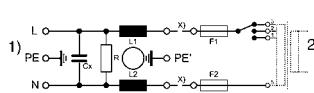

1) Line; 2) Load; x) external connection to be made by the customer

Standard version without voltage selector

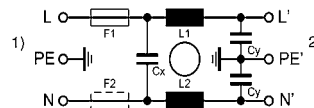

1) Line
2) Load

Medical version (M5) without voltage selector

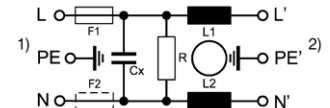

1) Line
2) Load

Medical version (M80) with voltage selector

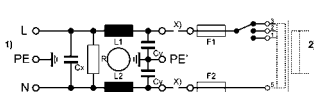

1) Line; 2) Load; x) external connection to be made by customer

Medical version (M80) without voltage selector

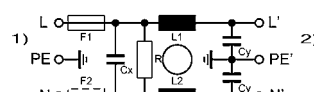

1) Line
2) Load

Derating Curves for Fuseholders

1-pole

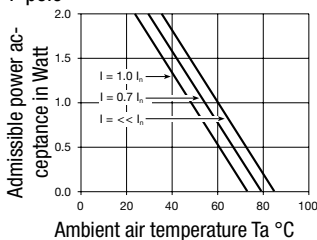

2-pole

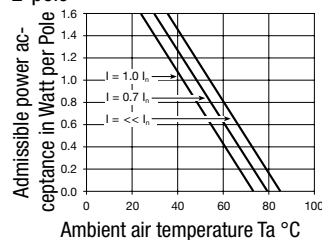

Attenuation Loss

Standard version

---- differential mode ____ common mode

1 A

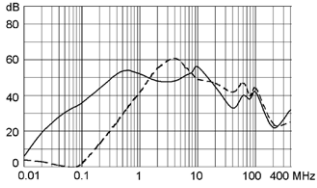

2 A

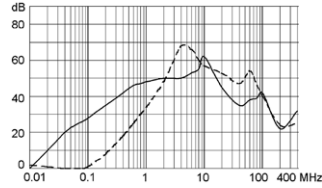

4 A

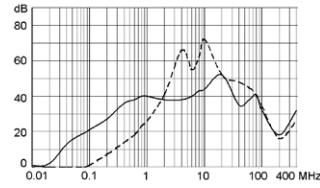

6 A

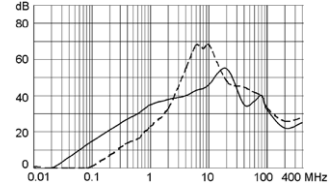

10 A

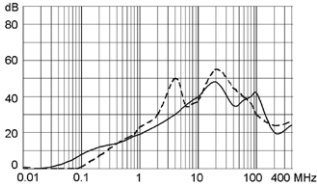

Medical version (M5)

1 A

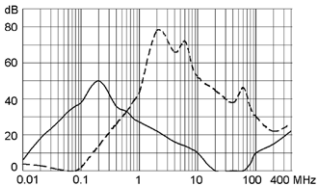

2 A

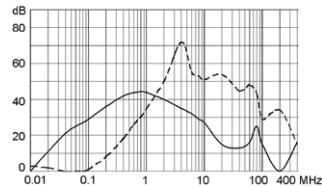

4 A

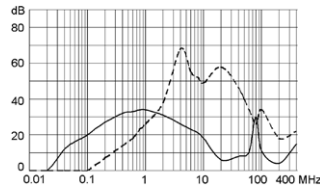

6 A

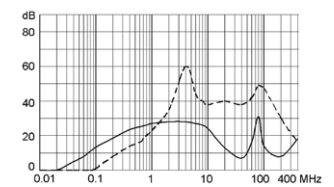

10 A

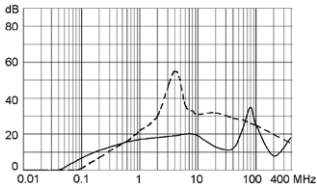

Variants

[Distributor-Stock-Check](#) | [SCHURTER-Stock-Check](#) | [e-Store](#)

Fuse drawer must be ordered separately (see accessories).

Rated Current [A]	Filter-Type	Panel mounting	Mounting side	Fuseholder	Terminal	Voltage selector	Order Number
1	Standard Version	Screw-on	Front-Side	2-pole	Quick connect terminals	-	4301.5001
1	Standard Version	Screw-on	Front-Side	1 pole	Quick connect terminals	-	4301.5011
1	Standard Version	Screw-on	Front-Side	2-pole	Quick connect terminals	3 digits	4301.5041
1	Standard Version	Screw-on	Front-Side	1 pole	Quick connect terminals	3 digits	4301.5051
1	Standard Version	Snap-in	Front-Side	2-pole	Quick connect terminals	-	4301.6001
1	Standard Version	Snap-in	Front-Side	1 pole	Quick connect terminals	-	4301.6011
1	Standard Version	Screw-on	Rear-Side	2-pole	Flexible wire18 AWG	-	4301.7301
1	Standard Version	Screw-on	Rear-Side	1 pole	Flexible wire18 AWG	-	4301.7311
1	Standard Version	Screw-on	Rear-Side	2-pole	Quick connect terminals	-	4301.7001
1	Standard Version	Screw-on	Rear-Side	1 pole	Quick connect terminals	-	4301.7011
2	Standard Version	Screw-on	Front-Side	2-pole	Quick connect terminals	-	4301.5002
2	Standard Version	Screw-on	Front-Side	1 pole	Quick connect terminals	-	4301.5012
2	Standard Version	Screw-on	Front-Side	2-pole	Quick connect terminals	3 digits	4301.5042
2	Standard Version	Screw-on	Front-Side	1 pole	Quick connect terminals	3 digits	4301.5052
2	Standard Version	Snap-in	Front-Side	2-pole	Quick connect terminals	-	4301.6002
2	Standard Version	Snap-in	Front-Side	1 pole	Quick connect terminals	-	4301.6012

Rated Current [A]	Filter-Type	Panel mounting	Mounting side	Fuseholder	Terminal	Voltage selector	Order Number
2	Standard Version	Screw-on	Rear-Side	2-pole	Quick connect terminals	-	4301.7002
2	Standard Version	Screw-on	Rear-Side	1 pole	Quick connect terminals	-	4301.7012
4	Standard Version	Screw-on	Front-Side	2-pole	Quick connect terminals	-	4301.5003
4	Standard Version	Screw-on	Front-Side	1 pole	Quick connect terminals	-	4301.5013
4	Standard Version	Screw-on	Front-Side	2-pole	Quick connect terminals	3 digits	4301.5043
4	Standard Version	Screw-on	Front-Side	1 pole	Quick connect terminals	3 digits	4301.5053
4	Standard Version	Snap-in	Front-Side	2-pole	Quick connect terminals	-	4301.6003
4	Standard Version	Snap-in	Front-Side	1 pole	Quick connect terminals	-	4301.6013
4	Standard Version	Screw-on	Rear-Side	2-pole	Quick connect terminals	-	4301.7003
4	Standard Version	Screw-on	Rear-Side	1 pole	Quick connect terminals	-	4301.7013
6	Standard Version	Screw-on	Front-Side	2-pole	Quick connect terminals	-	4301.5004
6	Standard Version	Screw-on	Front-Side	1 pole	Quick connect terminals	-	4301.5014
6	Standard Version	Screw-on	Front-Side	2-pole	Quick connect terminals	3 digits	4301.5044
6	Standard Version	Screw-on	Front-Side	1 pole	Quick connect terminals	3 digits	4301.5054
6	Standard Version	Snap-in	Front-Side	2-pole	Quick connect terminals	-	4301.6004
6	Standard Version	Snap-in	Front-Side	1 pole	Quick connect terminals	-	4301.6014
6	Standard Version	Screw-on	Rear-Side	2-pole	Quick connect terminals	-	4301.7004
6	Standard Version	Screw-on	Rear-Side	1 pole	Quick connect terminals	-	4301.7014
10	Standard Version	Screw-on	Front-Side	2-pole	Quick connect terminals	-	4301.5005
10	Standard Version	Screw-on	Front-Side	1 pole	Quick connect terminals	-	4301.5015
10	Standard Version	Screw-on	Front-Side	2-pole	Quick connect terminals	3 digits	4301.5045
10	Standard Version	Screw-on	Front-Side	1 pole	Quick connect terminals	3 digits	4301.5055
10	Standard Version	Snap-in	Front-Side	2-pole	Quick connect terminals	-	4301.6005
10	Standard Version	Snap-in	Front-Side	1 pole	Quick connect terminals	-	4301.6015
10	Standard Version	Screw-on	Rear-Side	2-pole	Quick connect terminals	-	4301.7005
10	Standard Version	Screw-on	Rear-Side	1 pole	Quick connect terminals	-	4301.7015
1	Medical Version (M5)	Screw-on	Front-Side	2-pole	Quick connect terminals	-	4301.5201
1	Medical Version (M5)	Screw-on	Front-Side	2-pole	Quick connect terminals	3 digits	4301.5241
1	Medical Version (M5)	Snap-in	Front-Side	2-pole	Quick connect terminals	-	4301.6201
1	Medical Version (M5)	Screw-on	Rear-Side	2-pole	Quick connect terminals	-	4301.7201
2	Medical Version (M5)	Screw-on	Front-Side	2-pole	Quick connect terminals	-	4301.5203
2	Medical Version (M5)	Screw-on	Front-Side	2-pole	Quick connect terminals	3 digits	4301.5243
2	Medical Version (M5)	Snap-in	Front-Side	2-pole	Quick connect terminals	-	4301.6203
2	Medical Version (M5)	Screw-on	Rear-Side	2-pole	Quick connect terminals	-	4301.7203
4	Medical Version (M5)	Screw-on	Front-Side	2-pole	Quick connect terminals	-	4301.5205
4	Medical Version (M5)	Screw-on	Front-Side	2-pole	Quick connect terminals	3 digits	4301.5245
4	Medical Version (M5)	Snap-in	Front-Side	2-pole	Quick connect terminals	-	4301.6205
4	Medical Version (M5)	Screw-on	Rear-Side	2-pole	Quick connect terminals	-	4301.7205
6	Medical Version (M5)	Screw-on	Front-Side	1 pole	Quick connect terminals	-	4301.5217
6	Medical Version (M5)	Screw-on	Front-Side	2-pole	Quick connect terminals	3 digits	4301.5247
6	Medical Version (M5)	Snap-in	Front-Side	2-pole	Quick connect terminals	-	4301.6207
6	Medical Version (M5)	Screw-on	Rear-Side	2-pole	Quick connect terminals	-	4301.7207
10	Medical Version (M5)	Screw-on	Front-Side	2-pole	Quick connect terminals	-	4301.5209
10	Medical Version (M5)	Screw-on	Front-Side	2-pole	Quick connect terminals	3 digits	4301.5249
10	Medical Version (M5)	Snap-in	Front-Side	2-pole	Quick connect terminals	-	4301.6209
10	Medical Version (M5)	Screw-on	Rear-Side	2-pole	Quick connect terminals	-	4301.7209
1	Medical Version (M80)	Screw-on	Rear-Side	2-pole	Quick connect terminals	-	4301.7202
2	Medical Version (M80)	Screw-on	Rear-Side	2-pole	Quick connect terminals	-	4301.7204
4	Medical Version (M80)	Screw-on	Rear-Side	2-pole	Quick connect terminals	-	4301.7206
6	Medical Version (M80)	Screw-on	Rear-Side	2-pole	Quick connect terminals	-	4301.7208
10	Medical Version (M80)	Screw-on	Rear-Side	2-pole	Quick connect terminals	-	4301.7200

Wire length: 150 mm

Packaging unit 10 Pcs

Required Accessory

Description

Fusedrawer 2

Fusedrawer with and without voltage selector insert



Fingergrip, 2-pole, Voltage selector, 110, 150, 220	4301.1014.01
Fingergrip, 2-pole, Voltage selector, 120, 240	4301.1014.02
Fingergrip, 2-pole, Voltage selector, 110, 220	4301.1014.03
Fingergrip, 2-pole, Voltage selector, 115, 220	4301.1014.04
...	...

Accessory

Assorted Covers

Rear Cover



0859.0075

Cord retaining kits

Cord retaining strain relieve



Flat head, A	4700.0001
Countersunk, B	4700.0002